

Wytrzymały profil najazdu!!!

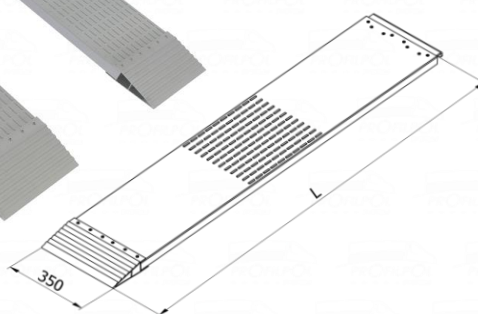

Typ zakończenia:

A

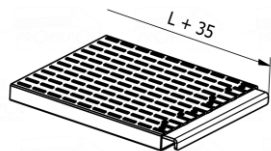
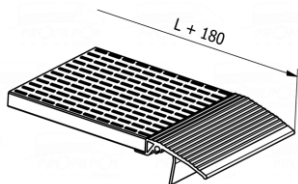
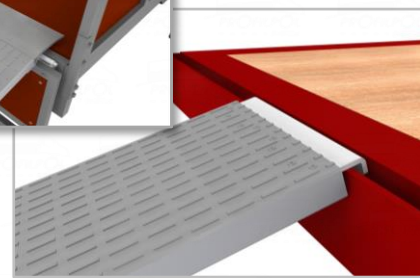
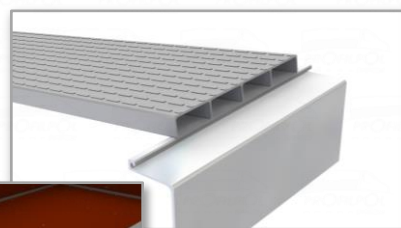
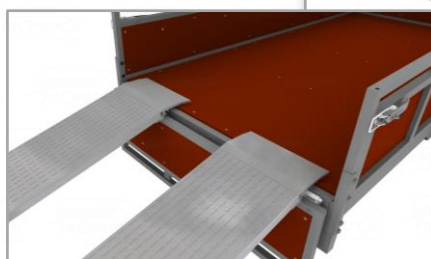
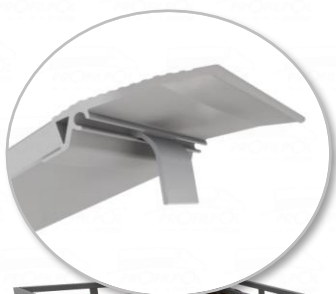
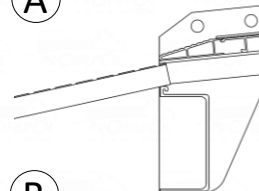

B

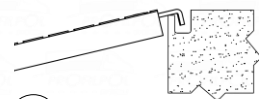

C

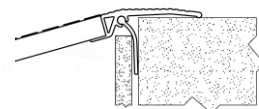

Nr katalogowy	Nazwa	Długość L	Waga kg/szt.
186NA233040 (A,B lub C)	Najazd aluminiowy 2,5 m	L=2,48 m	20,7*
186NA300040 (A,B lub C)	Najazd aluminiowy 3,15 m	L=3,15 m	23,8*

* waga podana dla zakończenia typu A



PROFILPOL
SYSTEM



www.profilpolsystem.pl



sprzedaz@profilpolsystem.pl



OLESNO

ul. Częstochowska 20
46-300 Olesno



+48 883 335 994

Klient:

Nr tel., e-mail:

Długość standardowa

L = 2,5 m

L = 3,15 m

Inna

L = _____ m

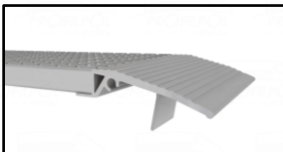
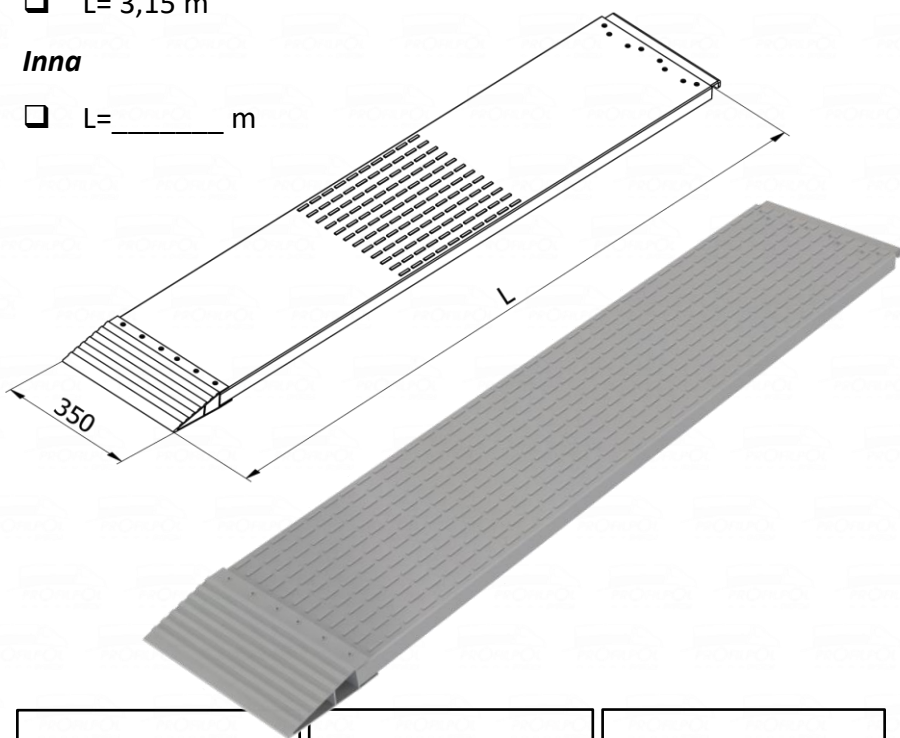

Nazwa	Długość L	Waga kg/szt.
Najazd aluminiowy 2,5 m	L=2,48 m	20,7*
Najazd aluminiowy 3,15 m	L=3,15 m	23,8*

* waga podana dla zakończenia typu A

Wytrzymały profil najazdu!!!



Warianty zakończenia najazdu:

TYP A (bez zakończenia) - **standard**

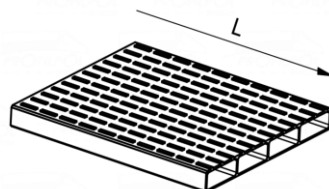

TYP B (zaczep stalowy) - **opcja**

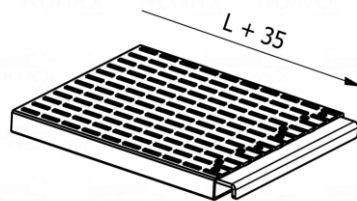

TYP C (zak. platformowe) - **opcja**

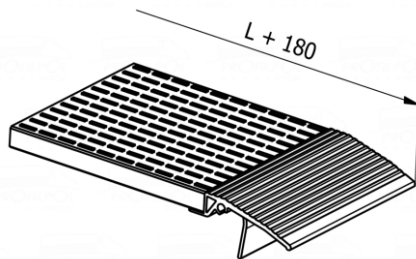

Notatki



PROFILPOL
SYSTEM



www.profilpolsystem.pl



sprzedaz@profilpolsystem.pl



OLESNO

ul. Częstochowska 20
46-300 Olesno



+48 883 335 994